



25, 26 y 27 de mayo

Aprendizaje de Ingeniería

Herramientas Abiertas o de Libre
Acceso

Código Libre

25, 26 y 27 de mayo

- Libertad no es lo mismo que gratuidad.
 - Código abierto.
 - Libertad de colaboración.
 - Software libre.
 - Sin pago de derechos.
 - Gratuito.

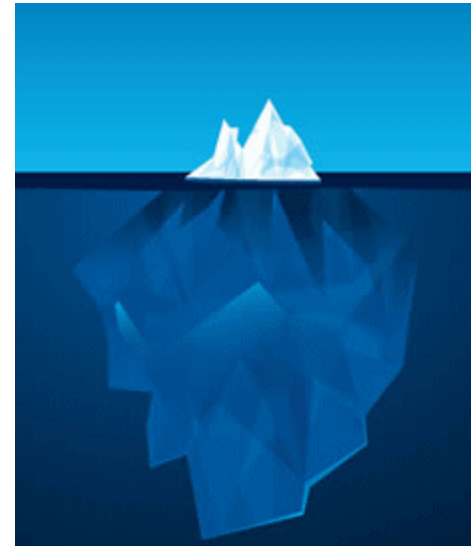

Software en la Educación

25, 26 y 27 de mayo

• Problemáticas:

- Costo.
- Administración de licencias.
- Confinamiento.
- Incompatibilidad con el estudiante.

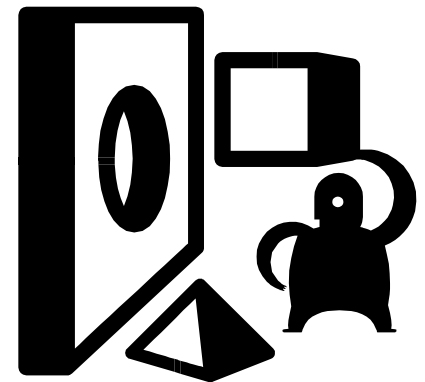



Solución Abierta

25, 26 y 27 de mayo

- El código abierto o el software libre no son una solución absoluta.
- Problemáticas:
 - Complejidad en la variedad de licencias.
 - No aptas para cardiacos.
 - No son lo que prevalece en la industria.



Sin Embargo

25, 26 y 27 de mayo

- Son extremadamente útiles en la academia.
 - Evolución acelerada.
 - Ideas diferentes.
 - Bajo costo de implementación.
 - Se cuenta con personal dedicado.



Implementación

25, 26 y 27 de mayo

- Tipos:
 - Instalación nativa o directa.
 - Cliente, Cliente-servidor.
 - Máquinas virtuales.
 - En la nube (pública o privada).
- Tomar en cuenta:
 - Continuidad.
 - Disponibilidad.
 - Capacidad.
 - Seguridad.
 - Costos.

CUDI 2011

Reunión de Primavera
Manzanillo, Colima



Software para Ingeniería

25, 26 y 27 de mayo

- Tratando de no ser muy extenso:
 - Ingeniería de software.
 - Diseño asistido por computadora (CAD).
 - Automatización de diseño electrónico (EDA).
 - Análisis de elementos finitos.
 - Programación numérica y visualización.
 - Visión de la computadora.
 - Aplicaciones del espacio.
 - Ofimáticos.
 - Negocios.



Ingeniería de Software

25, 26 y 27 de mayo

- SCM – control de versiones:
 - subversion, subclipse, tortoiseSVN, rapidSVN.
- Control de problemas:
 - Scarab.
- Levantamiento de requerimientos:
 - Xmlbasedsrs.
- Diseño:
 - ArgoUML.
- Construcción:
 - Antelope, scons, frameworx, build-interceptor.
- Prueba:
 - Maxq, aut.

Diseño Asistido por Computadora

25, 26 y 27 de mayo

BRL-CAD, BlenderCAD, OpenSCAD, Python CAD, VARKON, OpenCASCADE, FreeCAD.

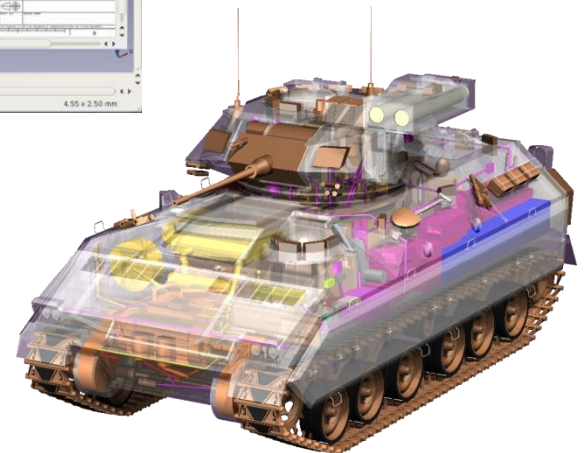
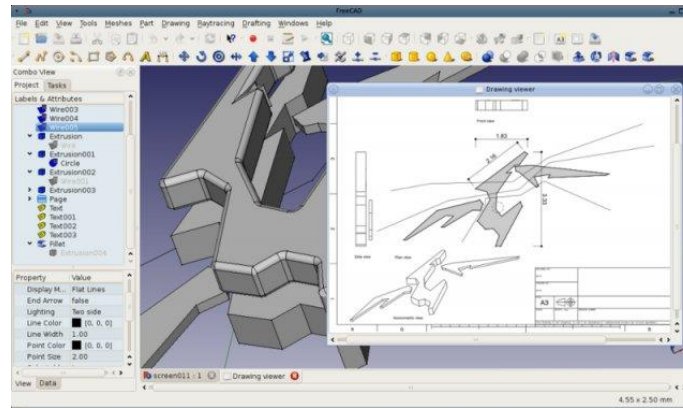
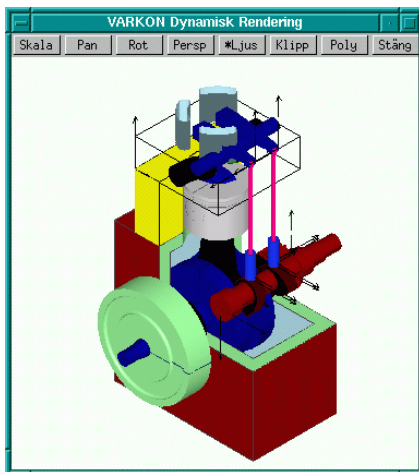

Automatización de Diseño Electrónico

25, 26 y 27 de mayo

- Chips, qucsStudio, zamiaCAD, Covered, Electric, gschem, pcb, gerbv, icarus, Free PCB, TinyCAD, KiCAD.

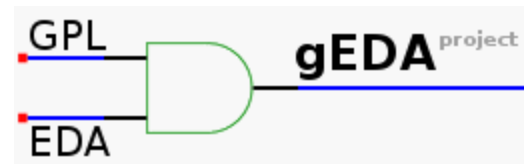



Análisis de Elementos Finitos

25, 26 y 27 de mayo

- Impact, SALOME, Elmer, Gmsh, OpenFVM.

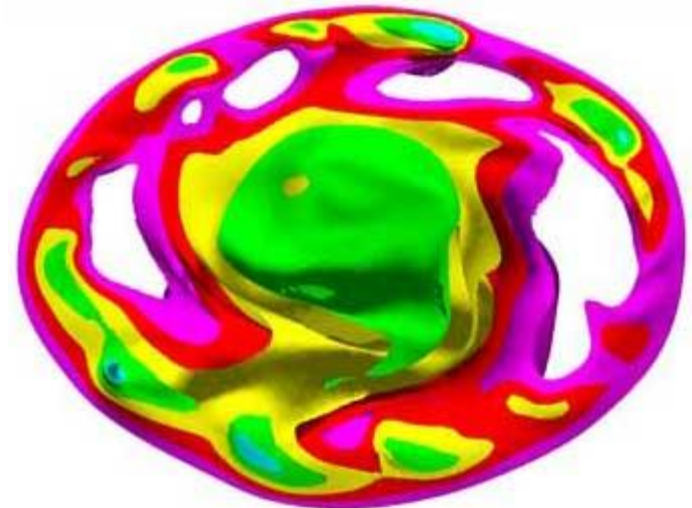
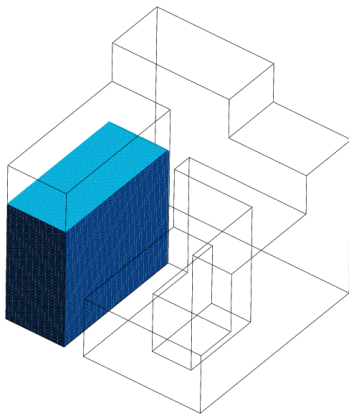
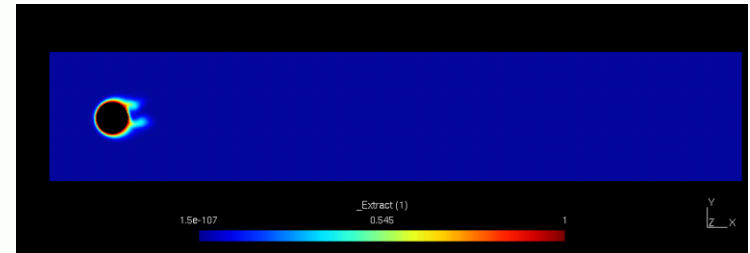
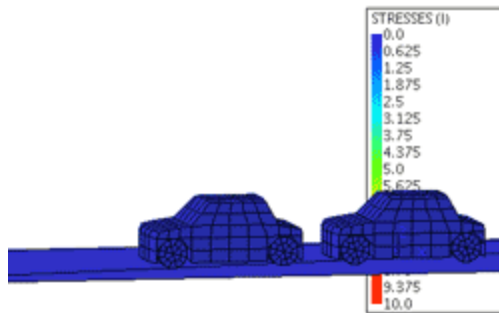

Programación numérica y visualización

25, 26 y 27 de mayo

Octave, SAGE, ASCEND, OpenDX, Visit, EngLab, SciLab, WorldWind, Numpy/Scipy.

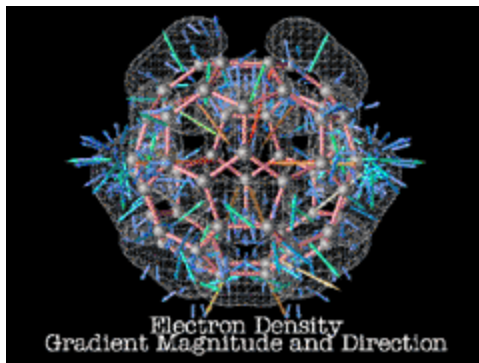

order

$$f(x) = e^{-x} \sin(x)$$
$$\hat{f}(x; 0) = x + O(x^2)$$

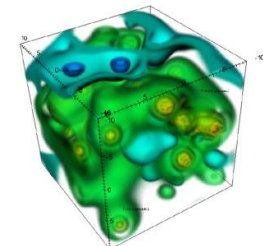
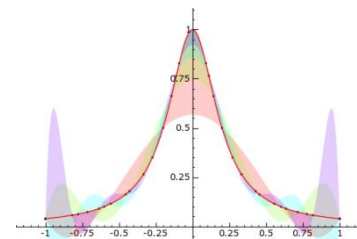
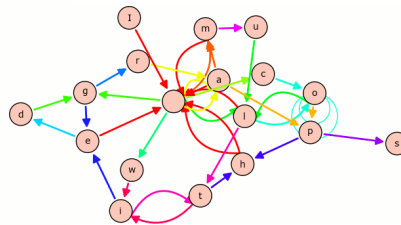
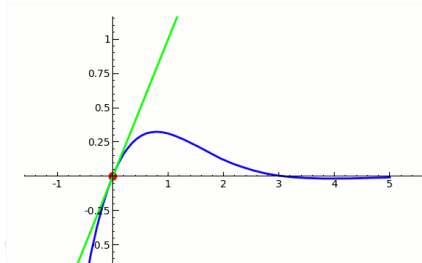
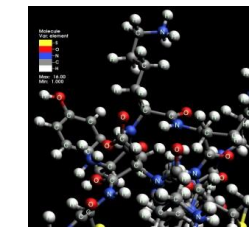
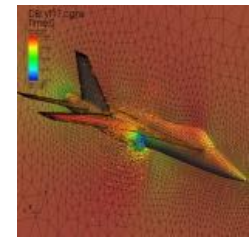
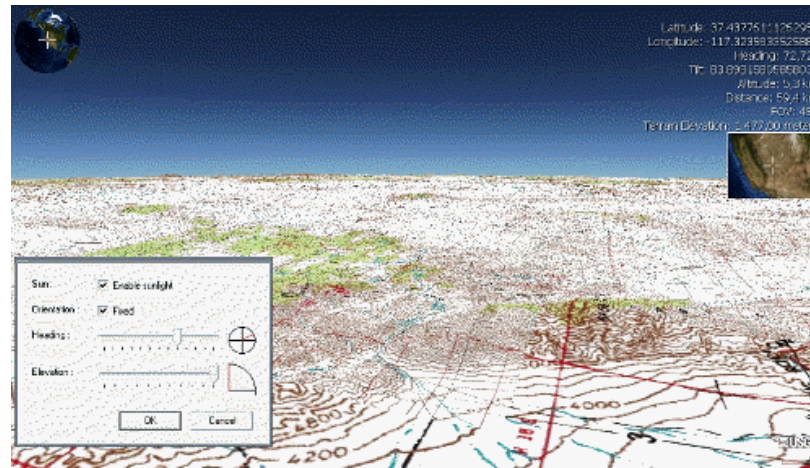

Visión de la Computadora

25, 26 y 27 de mayo

OpenCV, NASA Vision Workbench.



OpenCV Overview: > 500 functions
opencv.willowgarage.com

Robot support

- General Image Processing Functions
- Image Pyramids
- Geometric descriptors
- Segmentation
- Camera calibration, Stereo, 3D
- Features
- Utilities and Data Structures
- Tracking
- Machine Learning:
 - Detection
 - Recognition
- Fitting
- Matrix Math



Aplicaciones del Espacio

25, 26 y 27 de mayo

- Java astrodynamics toolkit, NASA General Mission Analysis Tool, OREKIT, Satellite tracking and orbit prediction, Orbit Reconstruction Simulation and Analysis, Asteroid Orbit Determination and Propagation, Libnova, Extensible Spacecraft Simulation and Modeling Environment, Rocket Workbench Project.

CUDI 2011

Reunión de Primavera
Manzanillo, Colima

Ofimáticos

25, 26 y 27 de mayo

OpenOffice, LibreOffice, Gnumeric, wikiCalc, Dia.

	A	B	C	D	E	F	G	H	I	J	K	L	M	N	O	P	Q	R	S	T
1	NPC	Name	Attacks							Leses	Transports (based on logics)				Total Resources	Food	Lumber	Stone	Iron	
2		attack	Archery	K	P	K	K	K												
3	1	40	50	12	12	18	18	18	6	43	56	31	27	34	31	215,000	100,000	20,000	20,000	20,000
4	2	60	100	100	50	20	25	0	71	59	31	44	39	36	355,000	200,000	30,000	30,000	30,000	
5	3	70	150	140	135	128	125	0	240	209	171	150	133	120	1,200,000	600,000	75,000	75,000	75,000	
6	4	120	300	275	225	200	0	0	452	377	303	269	251	226	2,240,000	1,400,000	120,000	120,000	120,000	
7	5	150	450	400	300	250	0	0	759	645	570	499	443	394	3,360,000	2,100,000	180,000	180,000	180,000	
8	6	180	600	525	375	300	0	0	1,046	857	743	655	578	520	4,500,000	2,800,000	200,000	200,000	200,000	
9	7	210	750	650	450	350	0	0	1,390	1,100	943	800	680	600	5,700,000	3,500,000	250,000	250,000	250,000	
10	8	240	900	750	525	400	0	0	1,780	1,420	1,200	1,000	850	750	7,000,000	4,200,000	300,000	300,000	300,000	
11	9	270	1,050	850	600	450	0	0	2,200	1,700	1,420	1,200	1,000	900	8,400,000	5,000,000	350,000	350,000	350,000	
12	10	300	1,200	950	675	500	0	0	2,650	2,000	1,620	1,350	1,150	1,000	9,900,000	5,800,000	400,000	400,000	400,000	
13	11	330	1,350	1,050	750	550	0	0	3,100	2,300	1,820	1,500	1,250	1,100	11,400,000	6,600,000	450,000	450,000	450,000	
14	12	360	1,500	1,150	825	600	0	0	3,580	2,600	2,000	1,650	1,350	1,200	12,900,000	7,400,000	500,000	500,000	500,000	
15	13	390	1,650	1,250	900	650	0	0	4,080	2,900	2,200	1,750	1,400	1,250	14,400,000	8,200,000	550,000	550,000	550,000	
16	14	420	1,800	1,350	975	700	0	0	4,580	3,200	2,400	1,850	1,450	1,300	15,900,000	9,000,000	600,000	600,000	600,000	
17	15	450	1,950	1,450	1,050	750	0	0	5,080	3,500	2,600	1,950	1,500	1,350	17,400,000	9,800,000	650,000	650,000	650,000	
18	16	480	2,100	1,550	1,125	800	0	0	5,580	3,800	2,800	2,050	1,550	1,400	18,900,000	10,600,000	700,000	700,000	700,000	
19	17	510	2,250	1,650	1,200	850	0	0	6,080	4,100	3,000	2,150	1,600	1,450	20,400,000	11,400,000	750,000	750,000	750,000	
20	18	540	2,400	1,750	1,275	900	0	0	6,580	4,400	3,200	2,250	1,650	1,500	21,900,000	12,200,000	800,000	800,000	800,000	
21	19	570	2,550	1,850	1,350	950	0	0	7,080	4,700	3,400	2,350	1,700	1,550	23,400,000	13,000,000	850,000	850,000	850,000	
22	20	600	2,700	1,950	1,425	1,000	0	0	7,580	5,000	3,600	2,450	1,750	1,600	24,900,000	13,800,000	900,000	900,000	900,000	
23	21	630	2,850	2,050	1,500	1,050	0	0	8,080	5,300	3,800	2,550	1,800	1,650	26,400,000	14,600,000	950,000	950,000	950,000	
24	22	660	3,000	2,150	1,575	1,100	0	0	8,580	5,600	4,000	2,650	1,850	1,700	27,900,000	15,400,000	1,000,000	1,000,000	1,000,000	
25	23	690	3,150	2,250	1,650	1,150	0	0	9,080	5,900	4,200	2,750	1,900	1,750	29,400,000	16,200,000	1,050,000	1,050,000	1,050,000	
26	24	720	3,300	2,350	1,725	1,200	0	0	9,580	6,200	4,400	2,850	1,950	1,800	30,900,000	17,000,000	1,100,000	1,100,000	1,100,000	
27	25	750	3,450	2,450	1,800	1,250	0	0	10,080	6,500	4,600	2,950	2,000	1,850	32,400,000	17,800,000	1,150,000	1,150,000	1,150,000	
28	26	780	3,600	2,550	1,875	1,300	0	0	10,580	6,800	4,800	3,050	2,050	1,900	33,900,000	18,600,000	1,200,000	1,200,000	1,200,000	
29	27	810	3,750	2,650	1,950	1,350	0	0	11,080	7,100	5,000	3,150	2,100	1,950	35,400,000	19,400,000	1,250,000	1,250,000	1,250,000	
30	28	840	3,900	2,750	2,025	1,400	0	0	11,580	7,400	5,200	3,250	2,150	2,000	36,900,000	20,200,000	1,300,000	1,300,000	1,300,000	
31	29	870	4,050	2,850	2,100	1,450	0	0	12,080	7,700	5,400	3,350	2,200	2,050	38,400,000	21,000,000	1,350,000	1,350,000	1,350,000	
32	30	900	4,200	2,950	2,175	1,500	0	0	12,580	8,000	5,600	3,450	2,250	2,100	39,900,000	21,800,000	1,400,000	1,400,000	1,400,000	
33	31	930	4,350	3,050	2,250	1,550	0	0	13,080	8,300	5,800	3,550	2,300	2,150	41,400,000	22,600,000	1,450,000	1,450,000	1,450,000	
34	32	960	4,500	3,150	2,325	1,600	0	0	13,580	8,600	6,000	3,650	2,350	2,200	42,900,000	23,400,000	1,500,000	1,500,000	1,500,000	
35	33	990	4,650	3,250	2,400	1,650	0	0	14,080	8,900	6,200	3,750	2,400	2,250	44,400,000	24,200,000	1,550,000	1,550,000	1,550,000	
36	34	1,020	4,800	3,350	2,475	1,700	0	0	14,580	9,200	6,400	3,850	2,450	2,300	45,900,000	25,000,000	1,600,000	1,600,000	1,600,000	
37	35	1,050	4,950	3,450	2,550	1,750	0	0	15,080	9,500	6,600	3,950	2,500	2,350	47,400,000	25,800,000	1,650,000	1,650,000	1,650,000	
38	36	1,080	5,100	3,550	2,625	1,800	0	0	15,580	9,800	6,800	4,050	2,550	2,400	48,900,000	26,600,000	1,700,000	1,700,000	1,700,000	
39	37	1,110	5,250	3,650	2,700	1,850	0	0	16,080	10,100	7,000	4,150	2,600	2,450	50,400,000	27,400,000	1,750,000	1,750,000	1,750,000	
40	38	1,140	5,400	3,750	2,775	1,900	0	0	16,580	10,400	7,200	4,250	2,650	2,500	51,900,000	28,200,000	1,800,000	1,800,000	1,800,000	
41	39	1,170	5,550	3,850	2,850	1,950	0	0	17,080	10,700	7,400	4,350	2,700	2,550	53,400,000	29,000,000	1,850,000	1,850,000	1,850,000	
42	40	1,200	5,700	3,950	2,925	2,000	0	0	17,580	11,000	7,600	4,450	2,750	2,600	54,900,000	29,800,000	1,900,000	1,900,000	1,900,000	
43	41	1,230	5,850	4,050	3,000	2,050	0	0	18,080	11,300	7,800	4,550	2,800	2,650	56,400,000	30,600,000	1,950,000	1,950,000	1,950,000	
44	42	1,260	6,000	4,150	3,075	2,100	0	0	18,580	11,600	8,000	4,650	2,850	2,700	57,900,000	31,400,000	2,000,000	2,000,000	2,000,000	
45	43	1,290	6,150	4,250	3,150	2,150	0	0	19,080	11,900	8,200	4,750	2,900	2,750	59,400,000	32,200,000	2,050,000	2,050,000	2,050,000	
46	44	1,320	6,300	4,350	3,225	2,200	0	0	19,580	12,200	8,400	4,850	2,950	2,800	60,900,000	33,000,000	2,100,000	2,100,000	2,100,000	
47	45	1,350	6,450	4,450	3,300	2,250	0	0	20,080	12,500	8,600	4,950	3,000	2,850	62,400,000	33,800,000	2,150,000	2,150,000	2,150,000	
48	46	1,380	6,600	4,550	3,375	2,300	0	0	20,580	12,800	8,800	5,050	3,050	2,900	63,900,000	34,600,000	2,200,000	2,200,000	2,200,000	
49	47	1,410	6,750	4,650	3,450	2,350	0	0	21,080	13,100	9,000	5,150	3,100	2,950	65,400,000	35,400,000	2,250,000	2,250,000	2,250,000	
50	48	1,440	6,900	4,750	3,525	2,400	0	0	21,580	13,400	9,200	5,250	3,150	3,000	66,900,000	36,200,000	2,300,000	2,300,000	2,300,000	
51	49	1,470	7,050	4,850	3,600	2,450	0	0	22,080	13,700	9,400	5,350	3,200	3,050	68,400,000	37,000,000	2,350,000	2,350,000	2,350,000	
52	50	1,500	7,200	4,950	3,675	2,500	0	0	22,580	14,000	9,600	5,450	3,250	3,100	69,900,000	37,800,000	2,400,000	2,400,000	2,400,000	
53	51	1,530	7,350	5,050	3,750	2,550	0	0	23,080	14,300	9,800	5,550	3,300	3,150	71,400,000	38,600,000	2,450,000	2,450,000	2,450,000	
54	52	1,560	7,500	5,150	3,825	2,600	0	0	23,580	14,600	10,000	5,650	3,350	3,200	72,900,000	39,400,000	2,500,000	2,500,000	2,500,000	
55	53	1,590	7,650	5,250	3,900	2,650	0	0	24,080	14,900	10,200	5,750	3,400	3,250	74,400,000	40,200,000	2,550,000	2,550,000	2,550,000	
56	54	1,620	7,800	5,350	3,975	2,700	0	0	24,580	15,200	10,400	5,850	3,450	3,300	75,900,000	41,000,000	2,600,000	2,600,000	2,600,000	
57	55	1,650	7,950	5,450	4,050	2,750	0	0	25,080	15,500	10,600	5,950	3,500	3,350	77,400,000	41,800,000	2,650,000	2,650,000	2,650,000	
58	56	1,680	8,100	5,550	4,125	2,800	0	0	25,580	15,800	10,800	6,050	3,550	3,400	78,900,000	42,600,000	2,700,000	2,700,000	2,700,000	
59	57	1,710	8,250	5,650	4,200	2,850	0	0	26,080	16,100	11,000	6,150	3,600	3,450	80,400,000	43,400,000	2,750,000	2,750,000	2,750,000	
60	58	1,740	8,400	5,750	4,275	2,900	0	0	26,580	16,400	11,200	6,250	3,650	3,500	81,900,000	44,20				



Negocios

25, 26 y 27 de mayo

- RapidI, RapidMiner, ¿Pentaho, JasperSoft?, SpagoBI, Vanilla, OpenI.

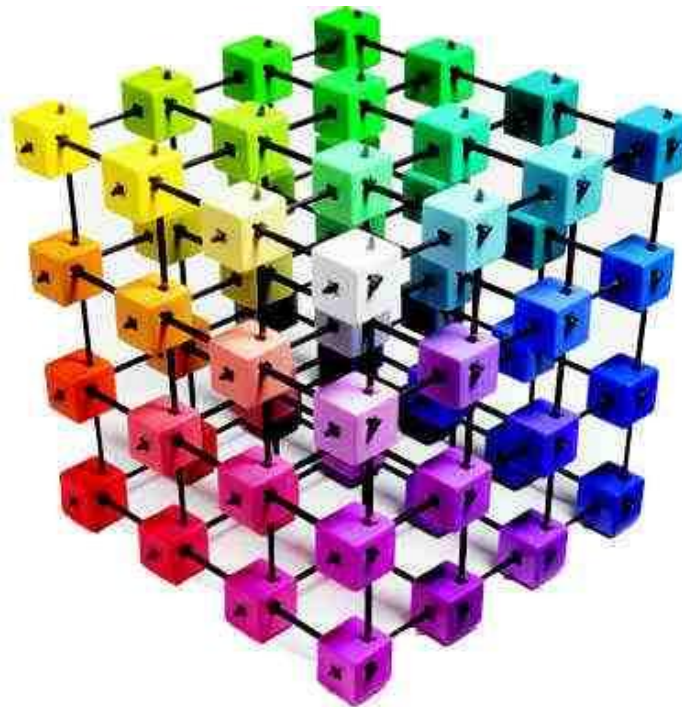



RapidI

25, 26 y 27 de mayo



CUDI 2011

Reunión de Primavera
Manzanillo, Colima

Openl

25, 26 y 27 de mayo

- Aplicación J2EE, corre sobre tomcat.
- Elementos básicos:
 - Conectores.
 - Definiciones de reporte.
 - Interface de usuario.
 - Seguridad.

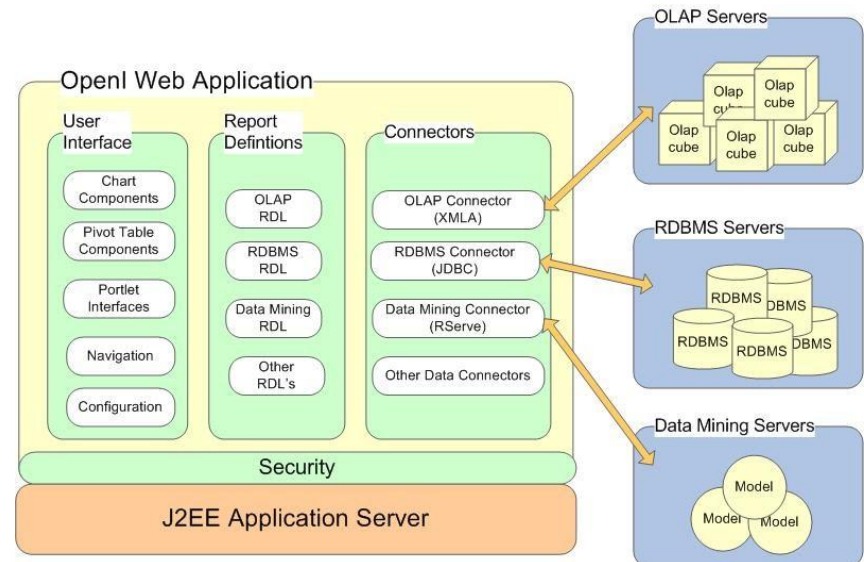



OpenI

25, 26 y 27 de mayo

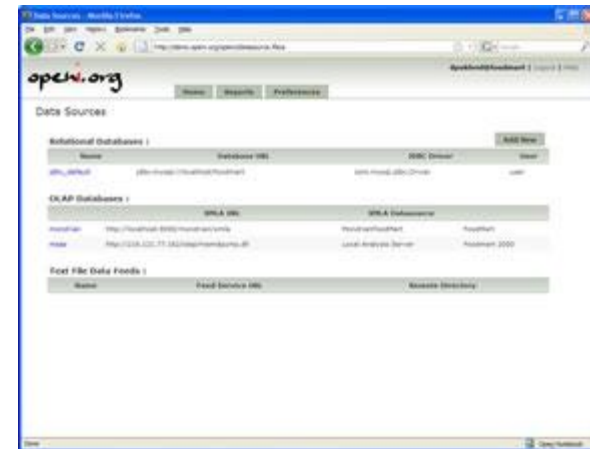
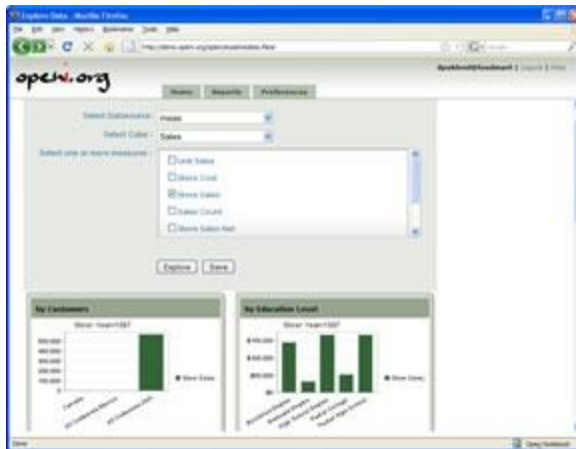
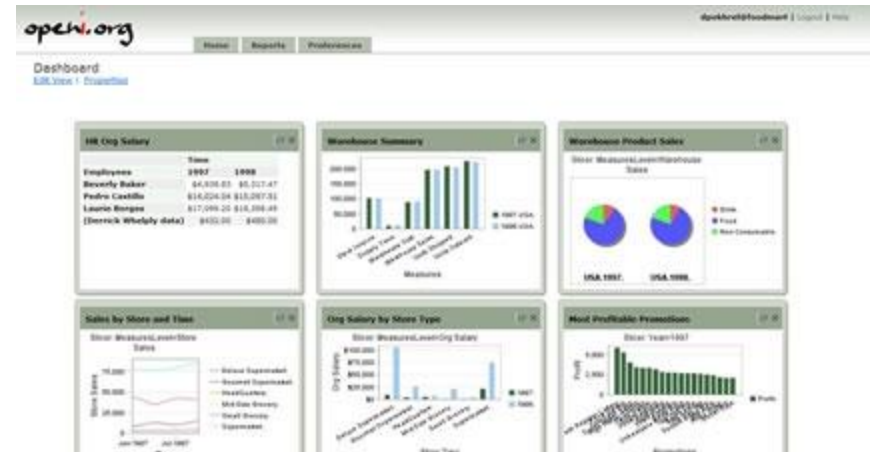
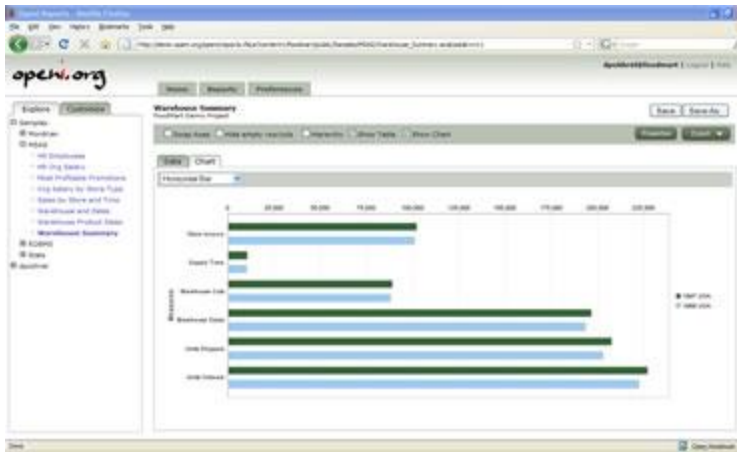

Vanilla

25, 26 y 27 de mayo

- Integración segura de metadatos.
- Manejo de KPI.
- Soporte a modelo SaaS.
- Plataforma de administración.
- Abstracción del xml.
- Ciclo ETL, cubos, reportes, tableros.
- Portal con funcionalidad BI.
- Soporte a SQL, OLAP.
- Soporte a FreeMetrics, FreeMetadata.



Vanilla

25, 26 y 27 de mayo

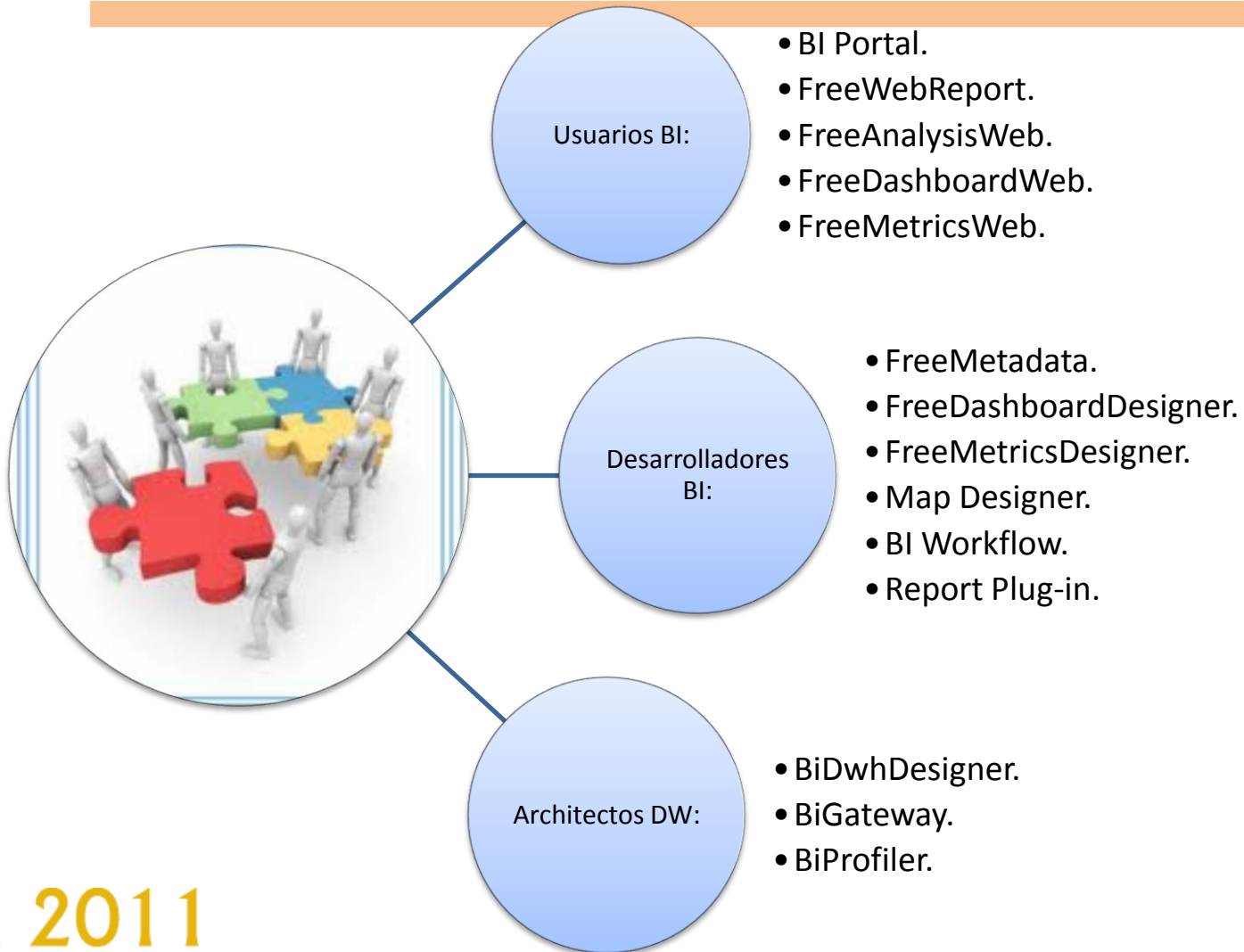



SpagoBI

25, 26 y 27 de mayo

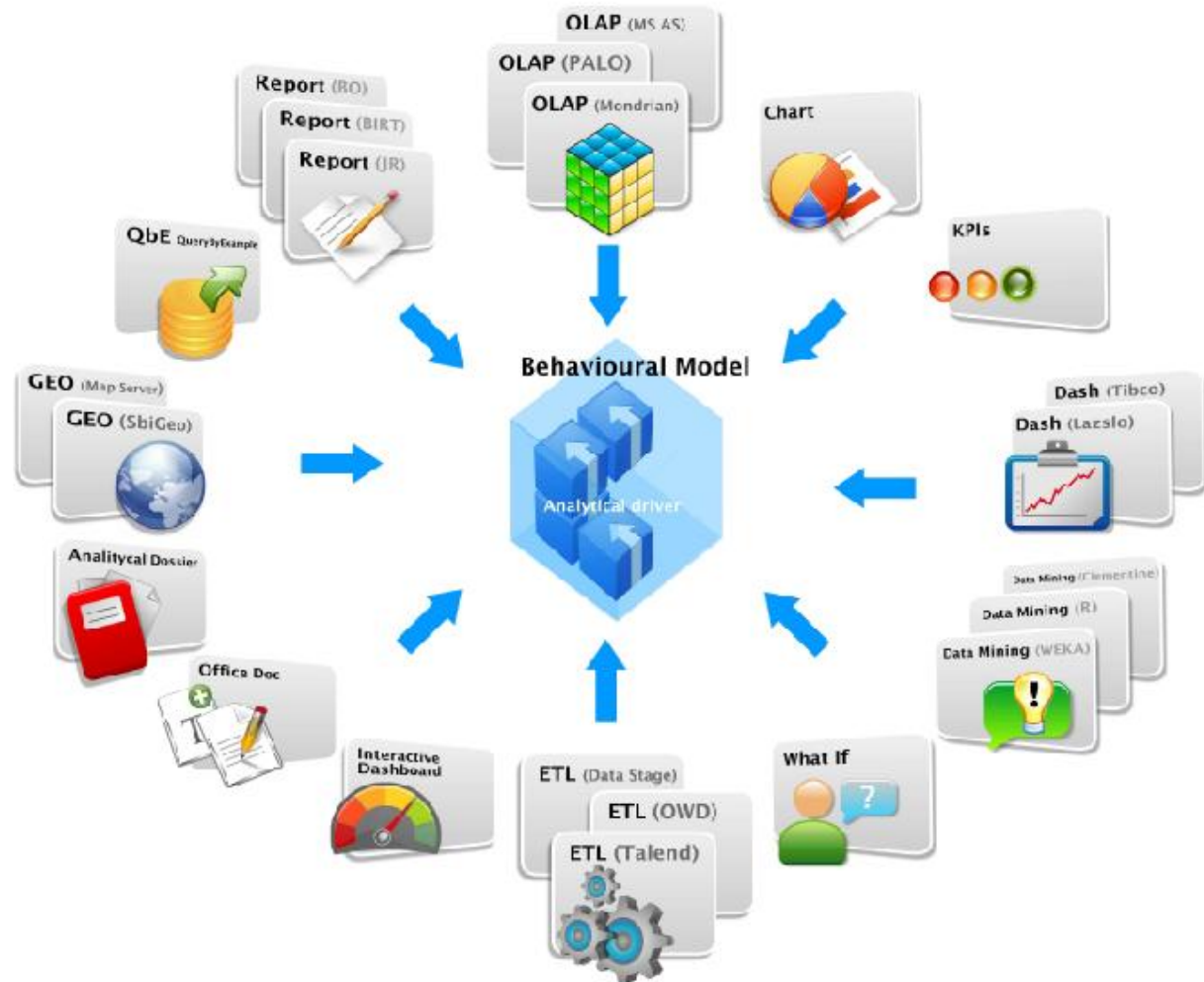



SpagoBI

25, 26 y 27 de mayo





SpagoBI

25, 26 y 27 de mayo

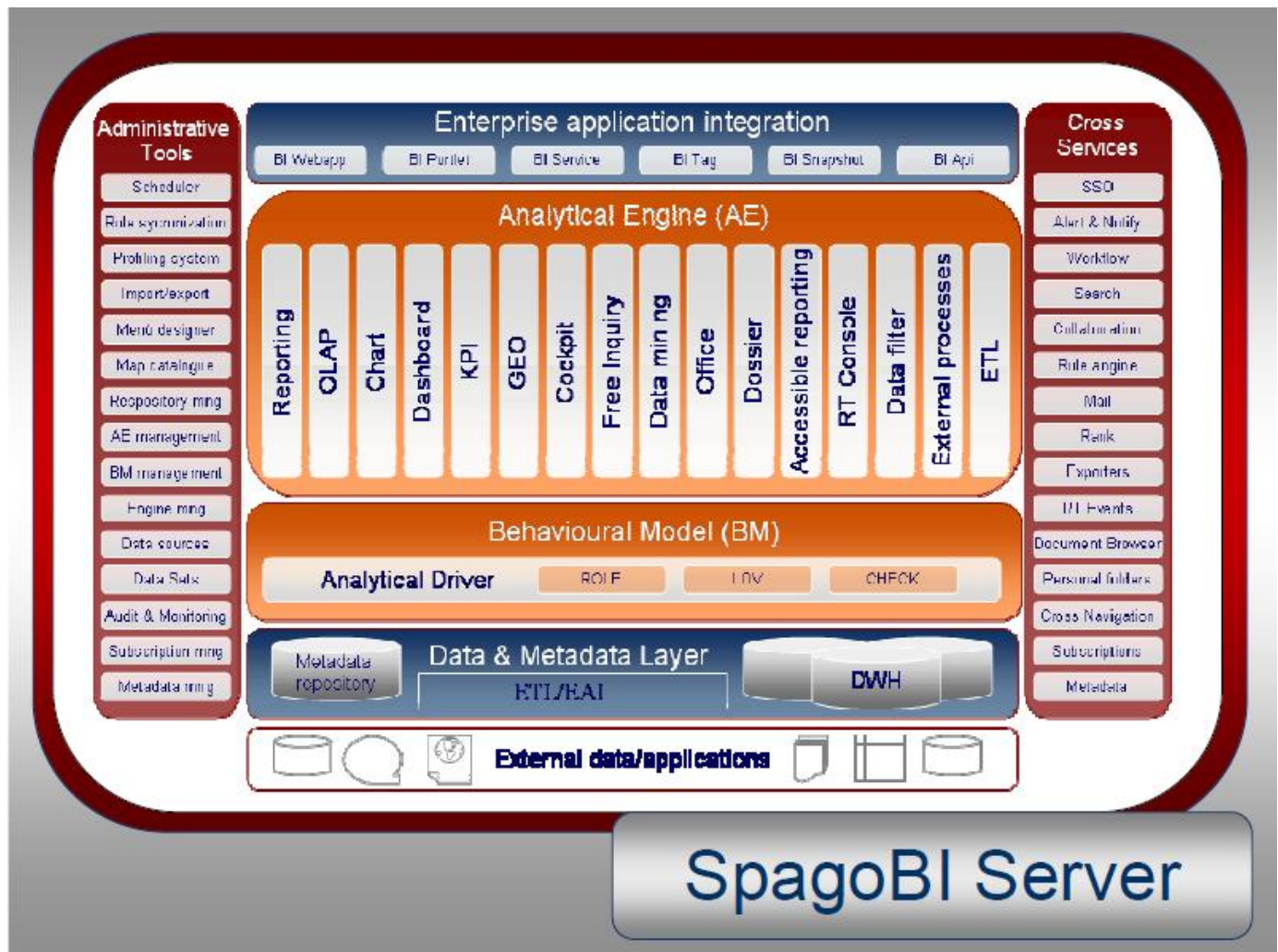



Conclusiones

25, 26 y 27 de mayo

- El código libre requiere de una evaluación previa a su implementación.
- El crecimiento de este modelo nos presenta nuevas y mayores opciones cada día.
- Colaborar e informar.



Gracias

25, 26 y 27 de mayo

- Izcóatl Armando Estañol Fuentes (ULSA)
- Comunidad de Medios Estudiantiles

CUDI 2011

Reunión de Primavera
Manzanillo, Colima